

EUM Series Electrically Released Brakes

Enclosed UniModules Contamination-Proof Design

Clean, quiet, operation. Nothing can get in, nothing can get out. Enclosed design eliminates damage to the working components. Prevents friction wear particles from escaping.

Totally Enclosed Version

The Enclosed UniModule packages the hardworking components from UM products into a totally enclosed housing. This rugged housing keeps wear particles in and contaminants out and provides quiet operation. Pre-burnished at the factory for rated torque directly out-of-box. When enclosed, they are suitable for most industrial applications and tolerate infrequent, light washing.

- Keeps contaminants out
- Keeps wear particles in
- Quiet operation
- Finned for heat dissipation
- UL listed when optional conduit box is installed

To convert any Gen 2 UniModule 50, 100, and 180 sizes to an enclosed model purchase optional Cover Kit
(part number 5370-101-076)

Enclosed UniModule Conversion

Enclosed UniModules, (EUMs) for 50, 100, and 180 sizes, are being replaced by GEN 2 UniModules (UMs) and an easy to install cover kit. Each kit contains (2) vent covers, (2) gaskets and (4) screws. A vent cover bolts to both sides of the UniModule unit to enclose the open vents of the housing creating a totally enclosed (non-washdown) brake package which keeps contaminants out and wear particles in for clean, quiet operation.



EUM-50

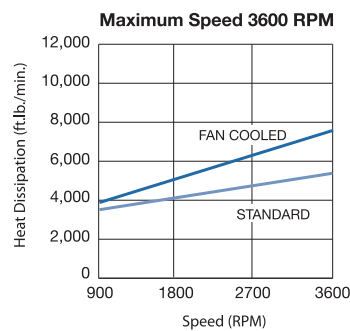

EUM-100/180

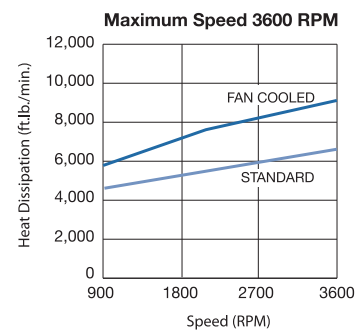

EUM Series Electrically Released Brakes

Preassembled, Totally Enclosed, Electrically Released Brake Units

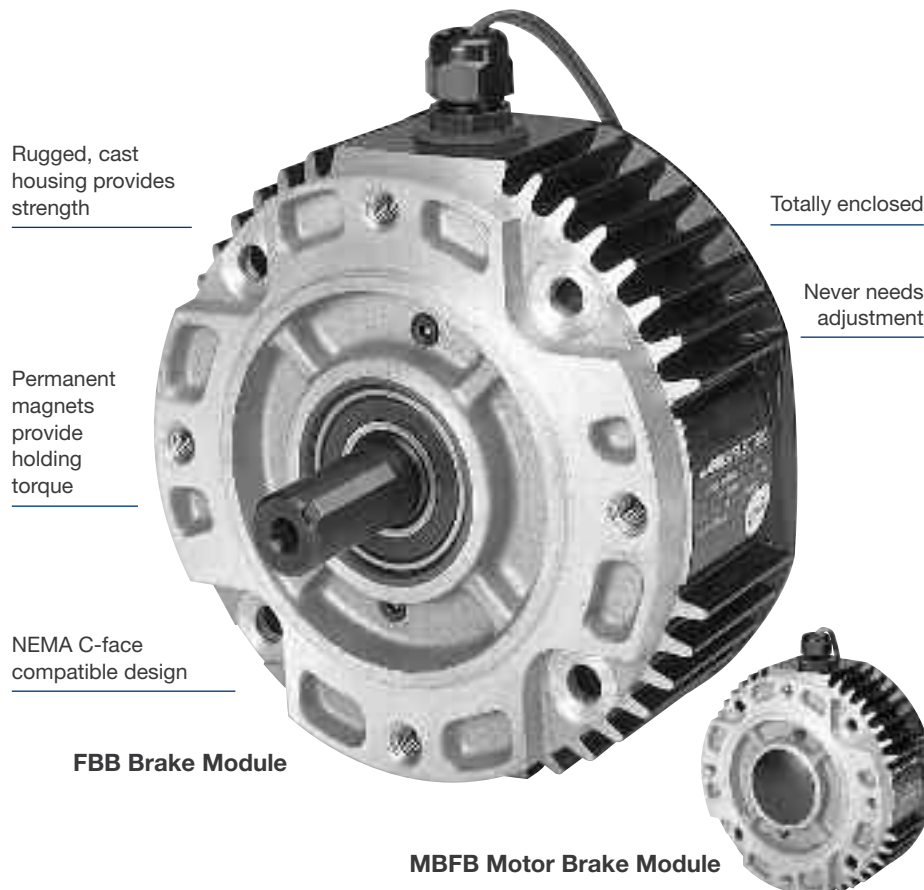

FBB Brake Module

MBFB Motor Brake Module

Available in Two Design Styles

EUM-FBB Brake Module

Use for brake alone applications. Mounts between a motor and gear box or reducer. Available in four sizes.

EUM-MBFB Motor Brake Module

Mounts to a double shafted C-face motor. Available in five sizes.

Warner Electric offers the convenience of pre-assembly in UniModule electrically released brake packages. Assembly, alignment, and preburnishing have been done at the factory. Bolt it on, wire it up, and your electrically released brake is ready to go. (Control and conduit box optional)

Care must be exercised to assure proper sizing and selection of electrically released brakes. Motor brakes are used for dynamic stopping and holding of loads when power is removed from the motor. Typical applications include conveyors, process equipment, and lifting devices.

Warner Electric brakes are designed for NEMA C-face motors which match the motor frame size and shaft diameter to the brake. To select a brake, determine the motor frame size and pick an MBFB for double shafted motors or an FBB for mounting between a motor and a gear reducer. Select the torque required for the

application. Higher torque brakes stop loads faster. Lower torque models provide softer stopping to prevent boxes on conveyors from tipping or skidding.

They are sized to provide nominal stopping of a motor in the event of power loss. If your application requires true "Fail safe" braking, the brake must be sized to meet or exceed peak motor torque and placed as close to the load shaft as possible. Peak motor torque can be determined by the formula:

$$\text{Peak Torque} = \frac{(\text{HP} \times 5250)}{\text{Motor Speed}}$$

EUM Series Electrically Released Brakes

EUM-FBB, EUM-MBFB Selection

Warner Electric Electrically Released Enclosed UniModules are available in two styles. The EUM-FBB Brake Module is used in brake only applications and mounts between a C-face motor and a gear box or reducer. The EUM-MBFB Motor Brake Module mounts to the back of a double shafted motor.

Note: Care must be exercised when selecting a brake to ensure it is sized properly for your application.

1. Select Configuration

a. FBB for NEMA C-face Mounting Between a Motor and Reducer

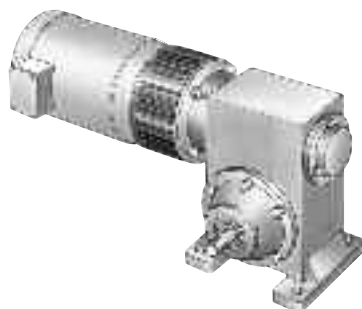

Verify that the brake will be cycled frequently.

Determine the NEMA C-face frame size of your motor and/or reducer, and choose the corresponding size Enclosed UniModule from the Frame Size Selection chart.

Size EUM-100 modules utilize a 5/8" diameter shaft to fit 56C/48Y motor frames with components of EUM-180 units for higher torque and heat dissipation capacity than the EUM-50.

EUM-FBB Frame Size Selection

NEMA Frame Size	EUM Size
56C/48Y	EUM-50* EUM-100**
182C/143TC	EUM-180
184C/145TC	EUM-180
213C/182TC	EUM-210
215C/184TC	EUM-210
213TC/215TC	EUM-215

*For 56C/48Y C-frame motors 3/4 HP and smaller, the EUM-100 size may be used where extended life is desirable.

**The EUM-100 size is recommended for motors 1 HP and larger.

b. MBFB for NEMA C-face Mounting on the Back of a Double Shafted Motor

Verify that the brake will be cycled frequently.

Determine the NEMA C-face frame size of your motor and/or reducer, and choose the corresponding size Enclosed UniModule MBFB from the Frame Size Selection chart, and verify that the motor shaft diameter and mounting bolt circle are the same for the brake and the motor.

Size EUM-100 modules utilize a 5/8" diameter shaft to fit 56C/48Y motor frames with components of EUM-180 units for higher torque and heat dissipation capacity than the EUM-50.

2. Determine Technical Requirements

Technical considerations for sizing and selection are torque and heat dissipation. Each merits careful consideration, especially heat dissipation as over time, use in excessive temperature environments will have an adverse effect on bearing life and coil wire insulation integrity.

Compare the calculated torque requirement with the average dynamic torque ratings. Select a unit with adequate torque. If the unit selected on torque is different than the unit selected based on heat, select the larger size unit.

EUM-MBFB Frame Size Selection

NEMA Frame Size	EUM Brake Size	Bolt Hole Mounting Circle	Motor Shaft Dia.
56C/48Y	EUM-50* EUM-100**	5.875	0.625
182C/143TC	EUM-180	5.875	0.875
184C/145TC	EUM-180	5.875	0.875
213C/182TC	EUM-210-7/8	7.25	0.875
215C/184TC	EUM-210	7.25	1.125

*For 56C/48Y C-frame motors 3/4 HP and smaller, the EUM-100 size may be used where extended life is desirable.

**The EUM-100 size is recommended for motors 1 HP and larger.

Horsepower vs. Shaft Speed

HP	SHAFT SPEED AT CLUTCH (IN RPM)																		
	100	200	300	400	500	600	700	800	900	1000	1100	1200	1500	1800	2000	2400	3000	3600	
1/4	✓	✓	✓	✓	✓	✓	✓	✓	✓	✓	✓	✓	✓	✓	✓	✓	✓	✓	✓
1/2	✓	✓	✓	✓	✓	✓	✓	✓	✓	✓	✓	✓	✓	✓	✓	✓	✓	✓	✓
3/4	✓	✓	✓	✓	✓	✓	✓	✓	✓	✓	✓	✓	✓	✓	✓	✓	✓	✓	✓
1	✓	✓	✓	✓	✓	✓	✓	✓	✓	✓	✓	✓	✓	✓	✓	✓	✓	✓	✓
1-1/2	✓	✓	✓	✓	✓	✓	✓	✓	✓	✓	✓	✓	✓	✓	✓	✓	✓	✓	✓
2	✓	✓	✓	✓	✓	✓	✓	✓	✓	✓	✓	✓	✓	✓	✓	✓	✓	✓	✓
3	✓	✓	✓	✓	✓	✓	✓	✓	✓	✓	✓	✓	✓	✓	✓	✓	✓	✓	✓
5	✓	✓	✓	✓	✓	✓	✓	✓	✓	✓	✓	✓	✓	✓	✓	✓	✓	✓	✓
7-1/2	✓	✓	✓	✓	✓	✓	✓	✓	✓	✓	✓	✓	✓	✓	✓	✓	✓	✓	✓
10	✓	✓	✓	✓	✓	✓	✓	✓	✓	✓	✓	✓	✓	✓	✓	✓	✓	✓	✓

EUM Series Electrically Released Brakes

a. Heat Dissipation Sizing

Friction surfaces slip during the initial period of engagement and, as a result, heat is generated. The clutch/brake selected must have a heat dissipation rating greater than the heat generated by the application. Therefore, in high inertia or high cycle rate applications, it is necessary to check the heat dissipation carefully. Inertia, speed and cycle rate are the required parameters.

Heat dissipation requirement is calculated as follows:

$$E = 1.7 \times WR^2 \times (N/100)^2 \times F$$

where:

$$E = \text{Heat (lb. ft./min.)}$$

WR^2 = Total reflected inertia at the clutch/brake shaft. Include the clutch/brake output inertia. (lb.ft.²)

N = Speed in revolutions per minute. (RPM)

F = Cycle rate in cycles per minute (CPM)

Compare the calculated heat generated in the application to the unit ratings using the heat dissipation curves. Select the appropriate unit that has adequate heat dissipation ability.

Heat Dissipation Curves

Size 50

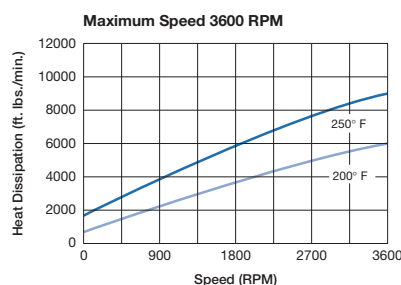

Size 100/180

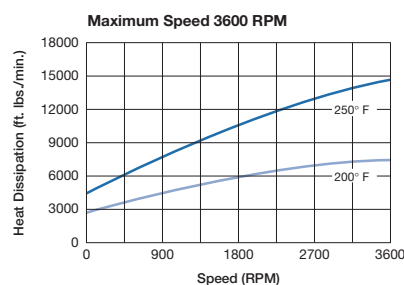

EUM 210/215 (fan not available for 215)

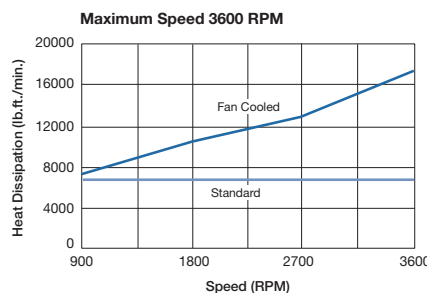

b. Torque Sizing

For most applications, the correct size clutch/brake can be selected from the Horsepower vs. Shaft Speed chart on page 153. Determine the motor horsepower and the RPM at the clutch/brake. The correct size unit is shown at the intersection of horsepower and shaft speed.

If the static torque requirements are known, refer to the technical ratings chart to select a unit.

For some applications, the torque requirement is determined by the time allowed to accelerate and decelerate the load. (This time is generally specified in milliseconds.) For these applications, it is necessary to determine the torque requirement based on load inertia and the time allowed for engagement.

The torque requirements are calculated as follows:

$$T = (WR^2 \times N) / (308 \times t)$$

where:

T = Average Dynamic Torque (lb. ft.)

WR^2 = Total reflected inertia at the clutch/brake shaft. Include the clutch/brake output inertia. (lb. ft.²)

N = Speed in revolutions per minute. (RPM)

t = Time allowed for the engagement (sec)

C-face Electrically Released Brakes Dynamic Torque Curves

Size 50

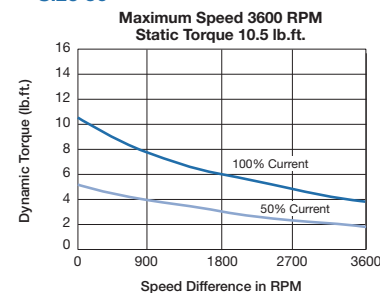

Size 100/180

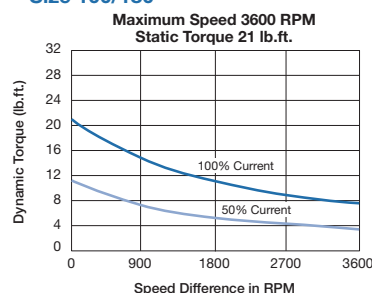

Size 210/215

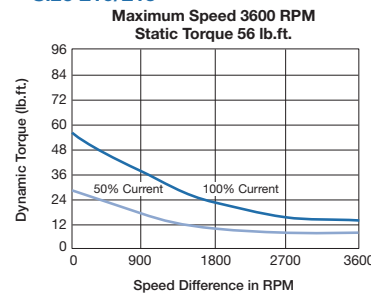

EUM Series Electrically Released Brakes

Preassembled, Totally Enclosed, Electrically Released Brake Units

Specifications

Size	Voltage DC	Static Torque (lb.ft.)	Max. Speed (RPM)	Total Weight (lbs.)	Armature (lb.ft. ²)	Component Inertia -WR ² (lb.ft. ²)				NEMA Frame Size
						FBB		MBFB		
						Hub	Shaft	Hub Spliced	Shaft Input	
50	90	6	3600	8.6	.009	.001	.0005	.001	.0003	56C/48Y
100	90	12	3600	10.5	.023	.002	.002	.002	.002	56C/48Y
180	90	12	3600	10.5	.023	.002	.002	.002	.002	182C/143TC 184C/145TC
210	90	32	3600	27	.081	.016	.016	.016	.007	213C/182TC 215C/184TC

3. Select Options

Warner Electric Enclosed UniModules can be fitted with several accessories to extend their capacity and ease of mounting.

4. Select Control

All electrically released modules require a control with a potentiometer that will vary brake channel output. For FBB and MBFB brake modules, the CBC-160, CBC-200, CBC-300, or CBC-500/550 is recommended. The FBC units require either a CBC-300 or a CBC 500/550 control.

EUM Series Electrically Released Brakes

Selection/Ordering Information

Selection Procedure

Note: Care must be exercised when selecting the proper brake size for your application.

The selection charts list NEMA motor frame sizes, motor shaft diameters, and the matching FBB or MBFB brakes.

To select a brake:

- Determine the motor NEMA C-face frame size.
- Select brake configuration
 - FBB to mount between a NEMA C-face motor and a gear reducer.
 - MBFB to mount on double shafted NEMA C-face motors.
- Select the brake model from the charts by the torque required – higher torque for faster stopping, lower torque for longer, “soft” stopping.

Note: Size 100 brakes are typically used on motors with a rating of 1 HP or greater.

- Important:** Verify that the motor shaft diameter and mounting bolt circle dimensions are the same for the brake selected and the motor.

Control Selection

An optional conduit box enclosure is available. All electrically released units require a control with a potentiometer to vary brake channel output. For FBB and MBFB brake modules, control models CBC-160, CBC-200, CBC-300, or CBC-500/550 are recommended. (See Controls Section.)

Frame Size

EUM Size	NEMA Frame Size	Bolt Hole Mounting Circle	FBB Motor to Reducer Shaft Dia.	MBFB Motor Brake Shaft Dia.
EUM-50	56C	5 7/8	5/8	5/8
EUM-100	56C	5 7/8	5/8	5/8
EUM-180	143TC 145TC	5 7/8	7/8	7/8
EUM-210-7/8	213TC 215TC	7 1/4	N/A	7/8
EUM-210	182TC 184TC	7 1/4	1 1/8	1 1/8
EUM-215	213TC 215TC	7 1/4	1 3/8	N/A

How to Order

- Specify model number and voltage or the corresponding part number.
- Specify conduit box, if desired. See the Controls Section.
- Specify required control unit. See the Controls Section.

Ordering Example

EUM-50-20FBB-6, 90V or 5370-169-983; 5370-101-042 conduit box; CBC-160-2 control.

Totally Enclosed EUM Model No.	Voltage D.C.	Original Design Part No.	COMBINED GEN 2 Part No. OR		SEPARATE GEN 2 Part Numbers	
			UniModule w/kit	UniModule	and	Cover Kit
EUM Series						
EUM-50-20FBB-6	90	5370-169-983	5370-169-260			N/A
EUM-100-20FBB-12	90	5370-169-989	5370-169-261			N/A
EUM-180-20FBB-12	90	5370-169-995	5370-169-262			N/A
EUM-210-20FBB-32	90	5371-169-078	N/A			N/A
EUM-210-20FBB-56	90	5371-169-082	N/A			N/A
EUM-215-20FBB-32	90	5371-169-086	N/A			N/A
EUM-215-20FBB-56	90	5371-169-090	N/A			N/A
EUM-50-20MBFB-6	90	5370-169-965	5370-169-263			N/A
EUM-100-20MBFB-12	90	5370-169-971	5370-169-264			N/A
EUM-180-20MBFB-12	90	5370-169-977	5370-169-265			N/A
EUM-50-20FBB-10	90	5370-169-986	5370-32	5370-169-279	and	5370-101-082
EUM-100-20FBB-21	90	5370-169-992	5370-33	5370-169-284	and	5370-101-082
EUM-180-20FBB-21	90	5370-169-998	5370-34	5370-169-289	and	5370-101-082
EUM-50-20MBFB-10	90	5370-169-968	5370-35	5370-169-249	and	5370-101-082
EUM-100-20MBFB-21	90	5370-169-974	5370-36	5370-169-254	and	5370-101-082
EUM-180-20MBFB-21	90	5370-169-980	5370-37	5370-169-259	and	5370-101-082
EUM-210-7/8-20MBFB-32	90	5371-169-064	N/A			N/A
EUM-210-7/8-20MBFB-56	90	5371-169-068	N/A			N/A
EUM-210--20MBFB-32	90	5371-169-056	N/A			N/A
EUM-210-20MBFB-56	90	5370-169-060	N/A			N/A

Accessories

Description	FBB Size	Part No.
Conduit Box	FBB series	5370-101-042
	All sizes	
Motor Mount Kit for 20 FBB	50/100/180	5370-101-079
	210/215	5371-101-012